

The LVD is designed to protect the main vehicle battery from over discharge, by disconnecting the auxiliary accessories when the main battery voltage drops below 22.8 Volts. The accessories remain disconnected until such time as the battery voltage reaches normal charge voltage. The unit is designed to carry auxiliary loads of up to 50 Amps maximum.

Installation

1. Disconnect the earth terminal from the battery.
2. Mount the unit away from moisture and any source of external heat (e.g. exhaust systems).
3. Connect the Blue control lead of the unit to MAIN bolt of the LVD.
4. Connect a lead between the AUX. bolt of the LVD and the positive of the equipment (6B&S recommended)
5. Connect a lead between the MAIN bolt of the LVD and the positive (+) terminal of the supply battery (6 B&S recommended)
6. Connect the Black lead of the unit to the vehicle earth (negative).
7. Reconnect the earth terminal to the main vehicle battery.
8. Start the vehicle and check the LVD LED turns on.
9. Turn off the vehicle and check LVD LED remains on.

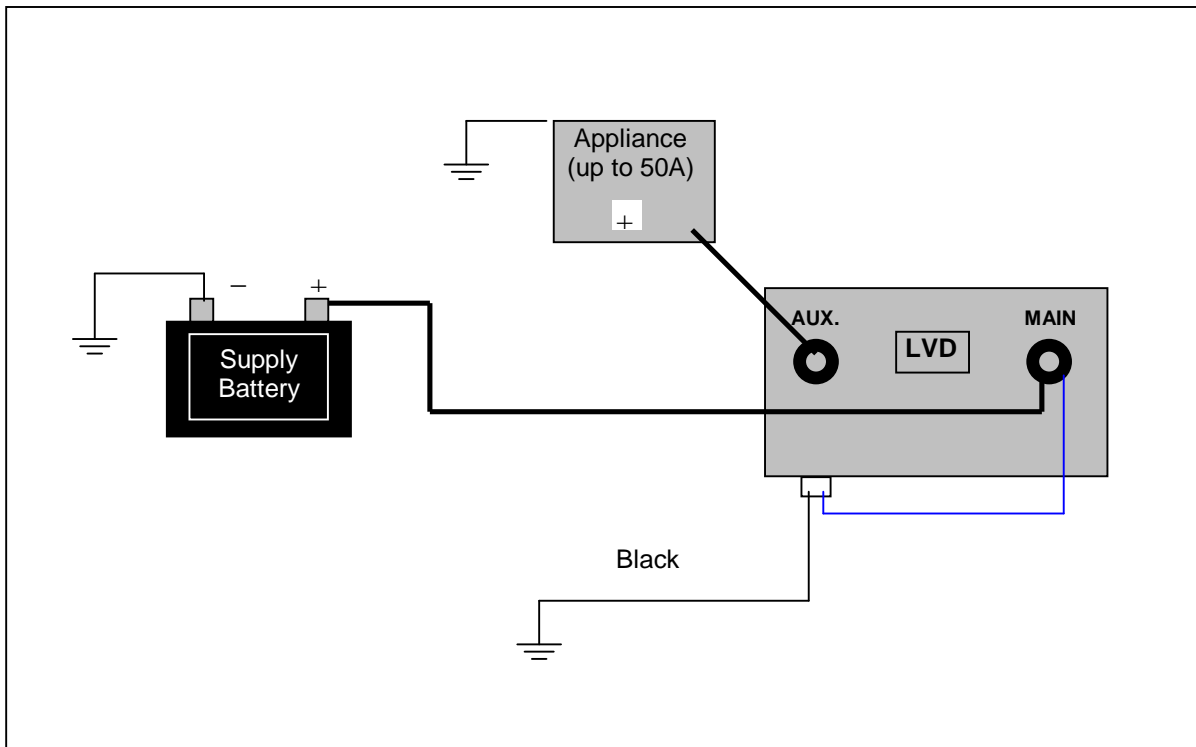

Warranty Conditions: The product is warranted to be free from defects in materials and workmanship under normal use and service for a period of 24 months from the date of sale. This warranty covers defective parts and workmanship provided that the product is shipped prepaid to the seller within 24 months of purchase of goods. This warranty is limited to the repair or replacement (at the manufacturers' discretion) of parts and shipping prepaid to the original despatch destination. We regret that no liability can be accepted for consequential or special damages of any kind howsoever arising in connection with products supplied by the seller. This warranty is in lieu of all other warranties expressed or implied. No representative is authorised to assume for the seller any other liability in connection with the seller's products.